



MagnumPlus - Operator's Manual
MagnumPlus - Manuel de l'utilisateur
MagnumPlus - Manual del operador
MagnumPlus - Betriebshandbuch
MagnumPlus - Bruksanvisning



Magnum +

TK 61110-4-OP (Rev. 0, 11/13)

TABLE OF CONTENTS

Table of Contents	1	Standard Display	17
Safety Instructions	2	Glossary of Symbols	18
General Precautions	2	Glossary of Mode Descriptions	19
Electrical Precautions	2	Navigating the Controller Operating Menu	22
Precautions	2	Menu Scrolling Keys	22
First Aid	3	Initiating a Manual Defrost	23
Low Voltage	3	PTI	24
Identifying Unit Safety and Warning Decals	5	Viewing Alarms/Warnings	24
Locating Serial Numbers	5	Display Alternate Fahrenheit (F) or Celsius (C) Temperatures	24
Unit Inspection	6	Changing Setpoint	24
Specifications	8	Controller Back-up Battery	24
System Net Cooling Capacity— Full Cool	8	Operating Theory	26
Evaporator Airflow Specifications	8	MAGNUM+ Operating Mode Function Chart	26
MP-4000 Controller Specifications	11	Diagnosis: Troubleshooting, Warnings and Alarm Codes	28
Physical Specifications	13	Introduction	28
Unit Description	14	Controller Diagnostics	28
Introduction	14	Emergency Cold Line	30
General Description	14	DECLARATION	31
Controller Description	16		
Controller Description	16		

SAFETY INSTRUCTIONS

GENERAL PRECAUTIONS

- Always wear goggles or safety glasses. Refrigerant liquid and battery acid can permanently damage the eyes.
- Never operate the unit with the discharge valve closed. Never close the compressor discharge valve with the unit in operation.
- Keep your hands, clothing and tools clear of the fans when the refrigeration unit is running. If it is necessary to run the refrigeration unit with covers removed, be very careful with tools or meters being used in the area.
- Never apply heat to a sealed refrigeration system or container.
- Fluorocarbon refrigerants produce toxic gases in the presence of an open flame or electrical arc. The gases are severe respiratory irritants capable of causing death.
- Firmly tighten all mounting bolts. Check each bolt for correct length for their particular application.
- Use caution when working around exposed coil fins. The fins can cause painful lacerations.
- Use caution when working with a refrigerant or refrigeration system in any closed or confined area with a limited air supply (for example, a trailer, container or in the hold of

a ship). Refrigerant tends to displace air and can cause oxygen depletion. This can result in suffocation and possible death.

- Use caution and follow the manufacturer's suggested practices when using ladders or scaffolds.

ELECTRICAL PRECAUTIONS

The possibility of serious or fatal injury from electrical shock exists when servicing a refrigeration unit. Extreme care must be used when working with a refrigeration unit that is connected to its power source. Extreme care must be used even if the unit is not running. Lethal voltage potentials can exist at the unit power cord, inside the control box, inside any high voltage junction box, at the motors and within the wiring harnesses.

PRECAUTIONS

In general disconnect the units power cord before repairing or changing any electrical components.

Note that even though the controller is turned off, one of the phases is still live and represents a potential danger of electrocution

Where turning of the unit is not possible (for example at voltage measuring or troubleshooting), follow safety precautions below.

- Turn the unit On/Off switch to Off before connecting or disconnecting the unit power plug. Never attempt to stop the unit by disconnecting the power plug.
- Be certain the unit power plug is clean and dry before connecting it to a power source.
- Use tools with insulated handles. Use tools that are in good condition. Never hold metal tools in your hand if exposed, energized conductors are within reach.
- Do not make any rapid moves when working with high voltage circuits. Do not grab a falling tool or other object. People do not contact high voltage wires on purpose. It occurs from an unplanned movement.
- Treat all wires and connections as high voltage until ammeter and wiring diagram show otherwise.
- Never work alone on high voltage circuits on the refrigeration unit. Another person should always be standing by in the event of an accident to shut off the refrigeration unit and to aid a victim.
- Have electrically insulated gloves, cable cutters and safety glasses available in the immediate vicinity in the event of an accident.

FIRST AID

IMMEDIATE action must be initiated after a person has received an electrical shock. Obtain immediate medical assistance.

The source of shock must be immediately removed. Shut down the power or remove the victim from the source. If it is not possible to shut off the power, the wire should be cut with either an insulated instrument (e.g., a wooden handled axe or cable cutters with heavy insulated handles). A rescuer wearing electrically insulated gloves and safety glasses could also cut the wire. Do not look at the wire while it is being cut. The ensuing flash can cause burns and blindness.

Pull the victim off with a non-conductive material if the victim has to be removed from a live circuit. Use the victim's coat, a rope, wood, or loop your belt around the victim's leg or arm and pull the victim off. *Do not touch* the victim. You can receive a shock from current flowing through the victim's body.

Check immediately for the presence of a pulse and respiration after separating the victim from power source. If a pulse is not present, start CPR (Cardio Pulmonary Resuscitation) and call for emergency medical assistance. Respiration may also be restored by using mouth-to-mouth resuscitation.

LOW VOLTAGE

Control circuits are low voltage (24 Vac and 12 Vdc). This voltage potential is not considered dangerous. Large amount of current available (over 30 amperes) can cause severe burns if shorted to ground. Do not wear jewelry, watch or rings. These items can shortcut electrical circuits and cause severe burns to the wearer.

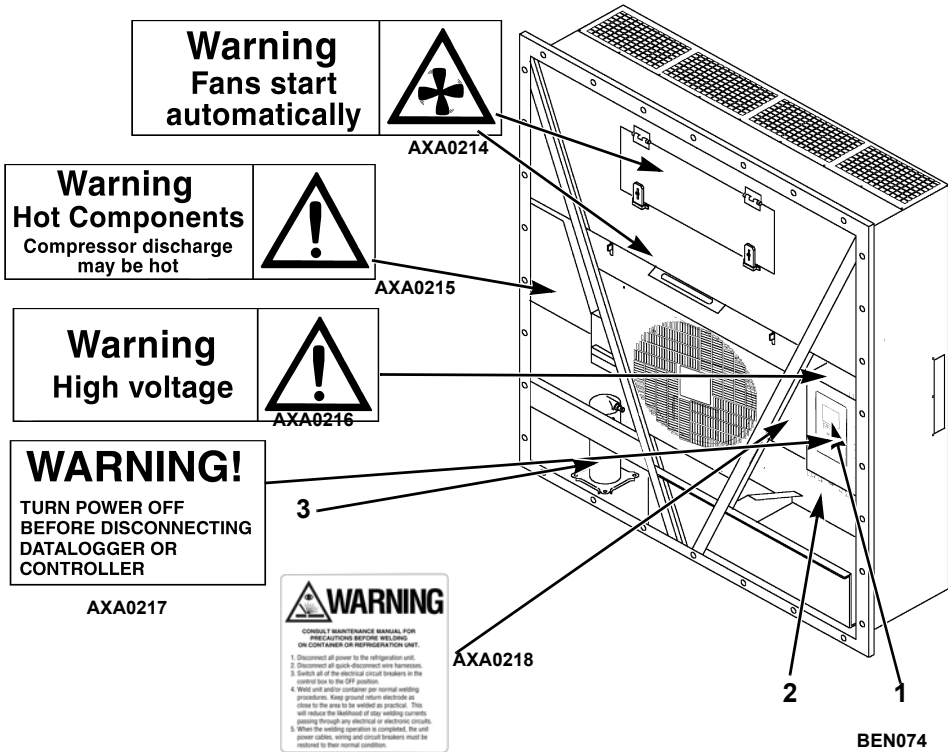

1.	Controller Nameplate
2.	Unit Nameplate
3.	Compressor Nameplate

Nameplate and Warning Locations

IDENTIFYING UNIT SAFETY AND WARNING DECALS

Serial number decals, refrigerant type decals and warning decals appear on all Thermo King® equipment. These decals provide information that may be needed to service or repair the unit. Service technicians should read and follow the instructions on all warning decals. See Figure .

LOCATING SERIAL NUMBERS

Serial numbers can be found on the component's nameplate.

- **Electric Motor Nameplate:** Attached to the motor housing.
- **Compressor Nameplate:** On front of the compressor.
- **Unit Nameplate:** On unit frame in power cord storage compartment.
- **MP-4000 Controller Nameplate:** On top of controller.

UNIT INSPECTION

A closely followed maintenance program will help to keep your Thermo King unit in top operating condition. The following service guide table should be used as a guide when inspecting or servicing components on this unit.

Pretrip	Inspect These Items
	Electrical
•	Perform a controller pretrip inspection (PTI) check.
•	Visually check condenser fan and evaporator fan.
•	Visually inspect electrical contacts for damage or loose connections.
•	Visually inspect wire harnesses for damage or loose connections.
	Refrigeration
•	Check refrigerant charge.
	Structural
•	Visually inspect unit for damaged, loose or broken parts.
•	Tighten unit, compressor and fan motor mounting bolts.

If a unit has been carrying cargo which contains a high level of sulphur or phosphorous (e.g. garlic, salted fish etc.), it is recommended that clean evaporator coil after each trip.

SPECIFICATIONS

SYSTEM NET COOLING CAPACITY— FULL COOL

MAGNUM+ Model — Air Cooled Condensing*

Return air to evaporator coil inlet	460/230V, 3 Phase, 60 Hz Power		
	Net Cooling Capacity		Power Consump
	60 Hz Capacity B/hr	60 Hz Capacity kW	60 Hz Power kW
21.1 C (70 F)	56,700	16.603	11.55
1.7 C (35 F)	40,945	11.990	11.03
-17.8 C (0 F)	24,785	7.258	7.57
-29 C (-20 F)	17,215	5.041	6.6
-35 C (-31 F)	14,000	4.104	6.03

*System net cooling capacity with a 38 C (100 F) ambient air temperature and R-404A.

EVAPORATOR AIRFLOW SPECIFICATIONS

	460/230V, 3 Phase, 60 Hz Power			380/190V, 3 Phase, 50 Hz Power		
	Heating Capacity			Heating Capacity		
	Watts	Kcal/hr	BTU/hr	Watts	Kcal/hr	BTU/hr
MAGNUM+ normal	5,250	4,515	17,914	3,900	3,353	13,300
MAGNUM+ extended	7,250	6,234	24,738	5,550	4,772	18,937

*System net heating capacity includes electric resistance rods and fan heat.

MAGNUM+

External Static Pressure (water column)	460/230V, 3 Phase, 60 Hz Power				380/190V, 3 Phase, 50 Hz Power			
	High Speed		Low Speed		High Speed		Low Speed	
	m ³ /hr	ft ³ /min	m ³ /hr	ft ³ /min	m ³ /hr	ft ³ /min	m ³ /hr	ft ³ /min
0 mm (0 in.)	6,560	3,860	3,170	1,865	5,480	3,225	2,710	1,595
10 mm (0.4 in.)	5,820	3,425	1,770	1,040	4,530	2,665	930	545
20 mm (0.8 in.)	5,000	2,940	—	—	3,750	2,205	—	—
30 mm (1.2 in.)	4,430	2,610	—	—	2,930	1,725	—	—
40 mm (1.6 in.)	3,520	2,070	—	—	1,870	1,100	—	—

Compressor Motor:	
Type	460/380V, 60/50 Hz, 3 Phase
Kilowatts	4.48 kW @ 460V, 60 Hz
Horsepower	6.0 hp @ 460V, 60 Hz
RPM	3550 RPM @ 460V, 60 Hz
Locked Rotor Amps	70 amps @ 460V, 60 Hz
Condenser Fan Motor:	
Type	460/380V, 60/50 Hz, 3 Phase
Kilowatts	0.55 kW @ 460V, 60 Hz
Horsepower	0.75 hp @ 460V, 60 Hz
Number: All Models	1
Motor:	
RPM	1725 RPM @ 460V, 60 Hz
Full Load Amps	1.0 amps @ 460V, 60 Hz; 1.0 amps @ 380V, 50 Hz

SPECIFICATIONS

Locked Rotor Amps	3.9 amps @ 460V, 60 Hz; 3.7 amps @ 380V, 50 Hz
Evaporator Fan Motors:	
Type	460/380V, 60/50 Hz, 3 Phase
Kilowatts	0.75 kW @ 460V, 60 Hz
Horsepower	1.0 hp @ 460V, 60 Hz
Motor:	
RPM (Each): High Speed	3450 RPM @ 460V, 60 Hz
Low Speed	1725 RPM @ 460V, 60 Hz
Full Load Amps (Each): High Speed	1.6 amps @ 460V, 60 Hz
Low Speed	0.8 amps @ 460V, 60 Hz
Locked Rotor Amps: High Speed	10.5 amps @ 460V, 60 Hz
Low Speed	9.0 amps @ 460V, 60 Hz
Electrical Resistance Heater Rods:	
Type	460/380V, 60/50 Hz, 3 Phase
Number	
Normal Capacity	6 (18 ga wire)
Normal Capacity	3 (18 ga wire)
Extended Capacity	3 (16 ga wire)
Watts (Each):	
Normal Capacity	680 Watts @ 460V, 60 Hz
Normal Capacity	1360 Watts @ 460V, 60 Hz
Extended Capacity	2000 Watts @ 460V, 60 Hz
Current Draw (Amps)	5 amps total @ 460V across each phase at heater contractor
Control Circuit Voltage:	
	29 Vac @ 60 Hz

MP-4000 CONTROLLER SPECIFICATIONS

Temperature Controller:	
Type	MP-4000 is a controller module for the Thermo King Magnum+ Unit. Additional requirements can be met by means of expansion modules. The MP4000 is solely responsible for temperature regulation of the reefer container, but other monitoring equipment can be used in conjunction with the MP 4000 - such as a chart recorder.
Setpoint Range	-40.0 to +30.0 C (-31.0 to +86.0 F)
Digital Temperature Display	-60.0 to +80.0 C (-76.0 to +176.0 F)
Controller Software (Original Equipment):	
Version	See controller identification decal
Defrost Initiation:	
Evaporator Coil Sensor	<p>Manual Switch or Demand Defrost Initiation: Coil must be below 18 C (65 F). Defrost cycle starts when technician or controller requests defrost initiation.</p> <p>Timed Defrost Initiation: Coil must be below 4 C (41 F). Defrost cycle starts 1 minute after the hour immediately following a defrost timer request for defrost initiation. For example, if the defrost timer requests a defrost cycle at 7:35, the defrost cycle will start at 8:01. Datalogger will record a Defrost event for each interval in which a Defrost cycle is pending or active (i.e. both the 8:00 and 9:00 data logs).</p>
Demand Defrost	<p>Demand defrost function initiates defrost when:</p> <ul style="list-style-type: none"> Temperature difference between the return air sensor and defrost (evaporator coil) sensor is too large for 90 minutes Temperature difference between the supply air sensors and return air sensor is too large
Defrost Timer:	
Chilled mode	Evaporator Coil Temperature must be below 5C (41 F) to activate the defrost compressor hour timer.

SPECIFICATIONS

MP-4000 CONTROLLER SPECIFICATIONS (CONTINUED)

Chilled Mode (continued)	There is an interval set for defrosting, however, the defrost timer is built intelligent - it detects whether or not there is ice building up on the coil. If there is no ice building up on the coil, it extends the defrost interval, and if there is ice building up earlier on the coil it reduces the defrost interval. The maximum interval is 48 hours.
Frozen mode	Every 8 hours of compressor operation. Defrost interval increases 2 hours each timed defrost interval. Maximum time interval in Frozen mode is 24 hours.
Reset to Base Time	Defrost timer resets if the unit is off more than 12 hours, setpoint is changed more than 5 C (9 F) or PTI pretrip test occurs.
Defrost Termination:	
Defrost (Coil) Sensor	Chilled mode: Terminates defrost when coil sensor temperature rises to 18 C (65 F). Frozen mode: Terminates defrost when coil sensor temperature rises to 18 C (65 F).
Termination Timer	Terminates defrost after 90 minutes at 60 HZ operation if coil sensor has not terminated defrost (120 minutes at 50 Hz operation)
Power Off	Turning Unit On/Off switch Off terminates defrost

MP-4000 CONTROLLER SPECIFICATIONS (CONTINUED)

Compressor Shutdown Protection (Auto Reset):	
Stops Compressor	148 C (298 F)
Allows Compressor Start	90 C (194 F)
Bulb Mode:	
Evaporator Fan Speed Settings	Flow High: High speed only Flow Low: Low speed only Flow Cycle: Fans will cycle between low and high speed every 60 minutes
Defrost Termination Temperature Setting	4 to 30 C (40 to 86 F)

PHYSICAL SPECIFICATIONS

Fresh Air Exchange Venting System (Adjustable):	
MAGNUM+	0 to 225 m ³ /hr (0 to 168 ft ³ /min.) @ 60 Hz 0 to 185 m ³ /hr (0 to 139 ft ³ /min.) @ 50 Hz
Evaporator Fan Blade Specifications:	
MAGNUM+:	
Diameter	355 mm (14.0 in.)
Pitch	25°
Number of Fans	2
Weight (net):	
MAGNUM+ Base Unit	380 Kg (875 lb.)
Water-cooled Condenser-Receiver Option	13.6 Kg (30 lb.)

UNIT DESCRIPTION

INTRODUCTION

This chapter will briefly describe the following items:

- General Unit Description.
- Standard Component Descriptions.
- Optional Component Descriptions.

GENERAL DESCRIPTION

MAGNUM units are all-electric, single-piece, refrigeration units with bottom air supply. The unit is designed to cool and heat containers for shipboard or overland transit. The unit mounts in the front wall of the container. Fork lift pockets are provided for installation and removal of the unit.

The frame and bulkhead panels are constructed of aluminum and are treated to resist corrosion. A removable evaporator compartment door provides service access. All components except the evaporator coil and electric heaters can be replaced from the front of the unit.

Each unit is equipped with an 18.3 m (60 ft.) power cable for operation on 460-380V/3 Ph/60-50 Hz power. The unit power cable is stored below the control box in the condenser section.

Each unit is equipped with 460-380V/3 Ph/60-50 Hz electric motors. An automatic phase correction system provides the proper electrical phase sequence for condenser fan, evaporator fan and compressor operation.

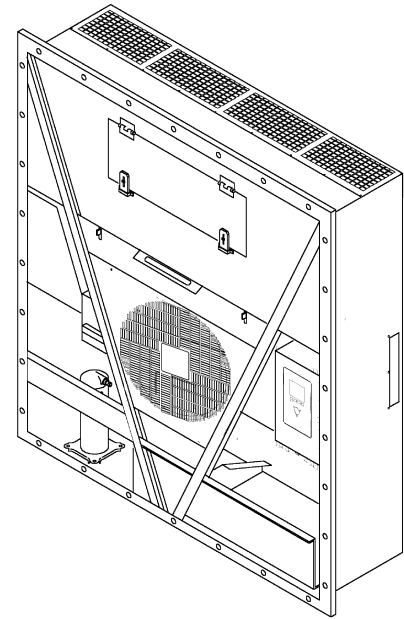

BEN074

Figure 1: MAGNUM+ Unit

The MAGNUM+ container unit features the following components:

- Scroll Compressor
- Compressor Digital Control Valve
- Economizer Heat Exchange System
- Temperature Sensors
- Fresh Air Exchange System
- Receiver Tank Sight Glass
- Evaporator Fans
- Condenser Fan Control
- Suction/Discharge Pressure Sensor (Optional)
- Remote Monitoring Receptacle Option (4-pin) (optional)
- Remote Monitoring Modem (RMM, RMM+) (Optional)
- USDA Cold Treatment Temperature Recording (Optional)
- Advanced Fresh Air Management (AFAM) and Advanced Fresh Air Management Plus (AFAM+) (Optional)

MP-4000 Controller

The MP-4000 is an advanced microprocessor controller that has been specially developed for the control and monitoring of refrigeration units. See “Controller Description and Operating Chapter” for more detailed information.

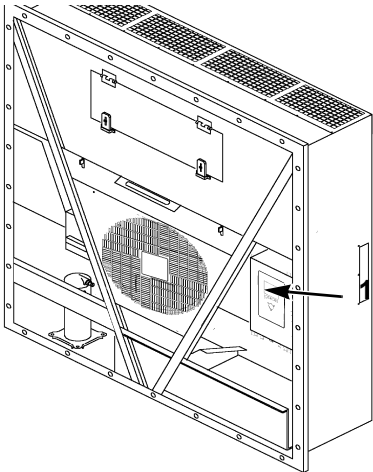

BEN074

1.	MP-4000 Controller
----	--------------------

Figure 2: MP-4000 Controller

CONTROLLER DESCRIPTION

CONTROLLER DESCRIPTION

The MP-4000 is an advanced microprocessor controller. It has been specially developed for the control and monitoring of refrigeration units. The controller contains the following basic features:

Temperature/Message Status Display:

- Temperature area. Displays Return air sensor, Supply air sensor, and Setpoint
- Message area. Displays Alarms, Message and Controller menu

Keypad:

- F1 – F4 Function keys navigate within the Status Display
- 2 Status LED indicators
- Special Function keys. ON/OFF, PTI, Defrost

Controller Back-up Battery

Every Controller has a Back-up Battery. This will allow the controller to be energized if the unit is not connected to shore power. The technician can change settings in the controller - Setpoint, etc.

Press the ON/OFF key, the controller will energize and stay energized for 25 sec, by pressing any of the Menu keys the 25 sec timer will reset to 20 sec.

Controller Input and Output Signals

The MP-4000 microprocessor controls all unit functions to maintain the cargo at the proper temperature. The controller also monitors and records system faults and performs pretrip.

The MP-4000 controller uses advanced solid-state integrated circuits to monitor and control unit functions. The controller monitors inputs from:

- Return Air Sensor
- Supply Air Sensor
- Evaporator Coil Sensor
- Condenser Coil Sensor
- Ambient Sensor
- Humidity Sensor
- USDA (Spare) Sensors 1, 2 and 3
- Compressor Discharge Line Temperature Sensor
- High Pressure Cutout Switch/Discharge Pressure Sensor
- Low Pressure Cutout Switch/Suction Pressure Sensor
- Phase measuring circuits
- Current measuring circuits
- Voltage measuring circuits

Output signals from the controller automatically regulate all unit functions including:

- Compressor operation
- Condenser fan operation
- Evaporator fan motor operation
- Compressor digital valve
- Vapor injection valve
- Dehumidify valve
- Electric heaters
- Phase selection

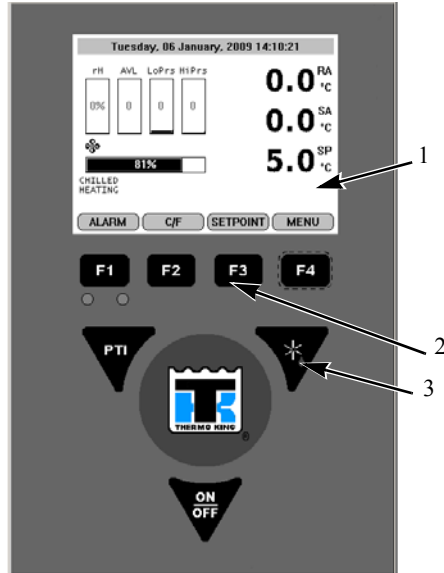

1.	Standard Display
2.	Function Keys
3.	Special Function Keys

MP-4000 Controller Display Panel

STANDARD DISPLAY

The Standard Display is a ¼ VGA graphical type display. The temperature can be displayed in Celsius or Fahrenheit.

The standard display will display the controlling sensor and Setpoint. The Setpoint will be the low reading with the C or F.

Once a key is pressed the Standard display will change to the Unit Status Display. After 2 min of no key activity the display will return the Standard display

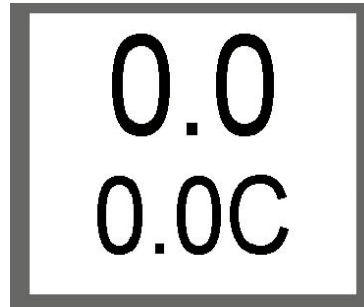

Standard Display

Idle Screen

After approximately 30 seconds of inactivity the display will go into hibernation and one of the following symbols will be displayed. Display alternates between the Idle screen and the standard display during this time.



The happy face => everything is ok



The Disgruntled face => we do have a warning



The unhappy face => we do have an alarm

Check Mark Symbol



The check mark symbol indication that a SmartPTI has recently been running and no problems was found. The thumb will only be shown in the normal operation state.

This symbol will appear at the left hand corner of the idle screen display.

Unit Status Display

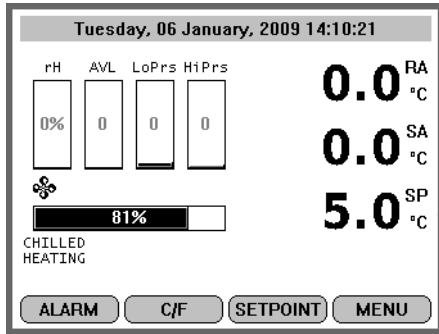

Unit Status Display

GLOSSARY OF SYMBOLS

	- Alarm
	- Pretrip Inspection / Test in Progress
	- Heating
	- Evaporator Fan High Speed
	- Evaporator Fan Low Speed

GLOSSARY OF SYMBOLS

	- Condenser Fan On
	- Watercooled
	- Dehumidification
	- Defrost
	- Compressor On Unloaded
	- Compressor On loaded without Vapour Injection
	- Compressor On loaded with Vapour Injection
	- SmartPTI has recently been running and no problems found
	- Controlling mode optimized
	- Bluetooth
	- Cell Phone

GLOSSARY OF SYMBOLS

	- GPS Signal
	- RMM

The Unit Status display will show.
Looking at the display from top to bottom

- Date and Time / Alarm Warning
- rH Relative Humidity sensor
- AVL Door Position/AFAM+
- LoPrs Low Pressure Transducer
- HiPrs High Pressure Transducer
- RA Return air sensor
- SA Supply air sensor
- SP Setpoint
- Mode Icons Compressor ON, Heater ON, Evap Fan ON
- Capacity Bar Graph Percentage of mode (100% is full on)

- Mode Description Descript unit operation
- F1 – f4 Key Functions ALARM C/F SETPOINT MENU

GLOSSARY OF MODE DESCRIPTIONS

Chilled/cooling

Chilled cooling is a mode where the Unit setpoint is set to above -10C. The function here is to maintain setpoint temperature by controlling the temperature on the supply air.

The supply air is not allowed to be lower than the setpoint. Chilled/cooling mode can operate the unit in different modes where the compressor can run loaded, unloaded/loaded and vapor injection depending on the need for cooling capacity. The condenser fan will operate in an on/off algorithm depending on the temperature on the condenser. The evaporator fans will operate in either high or low speed mode depending on the need for capacity.

Chilled/heating

Chilled heating is a mode the Unit setpoint is set to above -10C. The function here is to maintain setpoint temperature by controlling the temperature on the supply air.

The supply air is not allowed to be lower than the setpoint. Chilled heating mode can operate the unit where only the evaporator fan low speed is running, evaporator high speed is running or evaporator high speed and heat is on.

Frozen/cooling down

Frozen/cooling down mode where the Unit setpoint is set to below -10C. The function here is to maintain setpoint temperature by controlling the temperature on the return air.

Frozen/cooling down mode can operate the unit in different modes where the compressor is loaded and vapor injection is on/off. The condenser fan will operate in an on/off algorithm depending on the temperature on the condenser. The evaporator fans will operate in low speed mode or off.

Defrost

Defrost is a situation where the unit either on demand or timing is defrosting the evaporator coil. The unit is heating with the heating elements awaiting 18C on the evaporator sensor.

When the set Defrost termination temperature is reached, the unit will return to the operation mode depending on the setpoint.

PTI

PTI is a pretrip inspection and is used to diagnose the condition of the unit. There are a possibility to chose between several type of PTI's depending on the test needed to secure the functionality of the unit.

Function Keys

The function keys are the F1 - F4 keys located below the display. They allow the operator to move quickly to a specific area of the information or into the controller menu.

Function keys will change based on what menu is active in the display

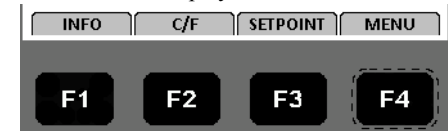

Function Keys

- F1 INFO key: Press to view an explanation for the current alarms present.
- F2 C/F key: Press to view alternate temperature scale Celsius or Fahrenheit in display.
- F3 SETPOINT key: Press to enter Setpoint menu. Press F2 Up or F3 Down keys to increase or decrease the Setpoint. Press and

Hold F4 until you are returned back to the main menu.

- F4 MENU key: Press to view the extended Menu for the MP4000

Indicator LEDs

Two status indicator LEDs are located just under the F1-F4 function keys

Green Led	Flashing	Temperature approaching in-range
	Solid	Temperature In-Range
Red Led	Flashing	Alarm present and has not been acknowledged
	Solid	Alarm present and has been acknowledged

Three Special Function Keys

The Special Function keys are located around the TK Logo. These special function key allow the operator to move quickly to perform a specific function

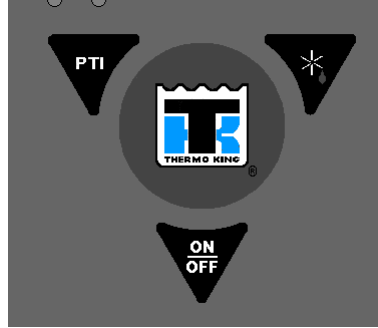

Special Function Keys

PTI	Pre-Trip Inspeccion
*	Defrost
ON OFF	Unit On/OFF Control

NAVIGATING THE CONTROLLER OPERATING MENU

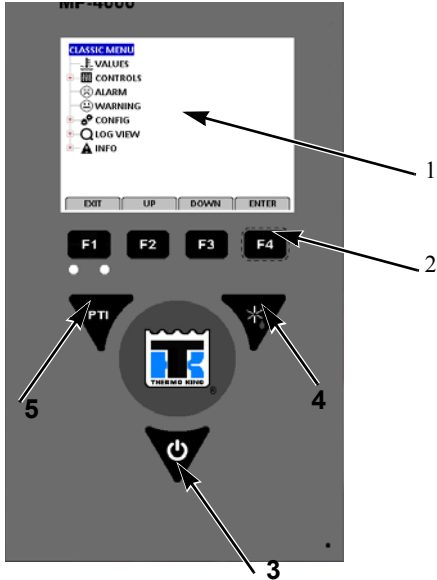

1.	Classic Main Menu
2.	Menu Scrolling Keys
3.	ON/OFF Key
4.	Defrost Key
5.	PTI - Pre-trip Inspection

MP-4000 Controller Display Panel

MENU SCROLLING KEYS

Moving through these seven menus, their submenus and entering commands requires the use of four keys:

- F1** **EXIT** - Press the **F1** key each time you want to exit a submenu shown in the message display.
- F2** **UP/ DOWN**- Press the **F2** or **F3** key each time you want to scroll up or down in a menu or submenu shown in the Message Display; or scroll forward or backward in a menu line.
- F3**
- F4** **ENTER** - Press the **F4** key to enter a new menu or submenu.

The MP-4000 contains an extensive operating menu. The menu is navigated via the controller keypad. There are 2 types of menu's that can be displayed

1. The Classic Main menu is divided into seven major areas that can be navigated via keypad.

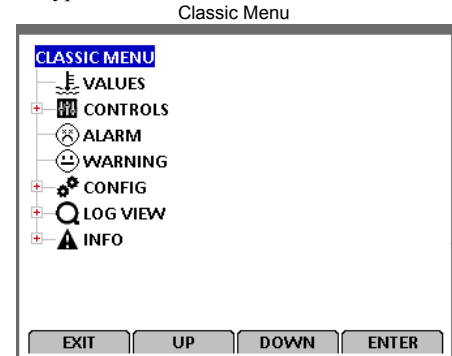

2. The icon Main menu is divided into 5 icons (Alarms and warnings appear under “Info” icon)

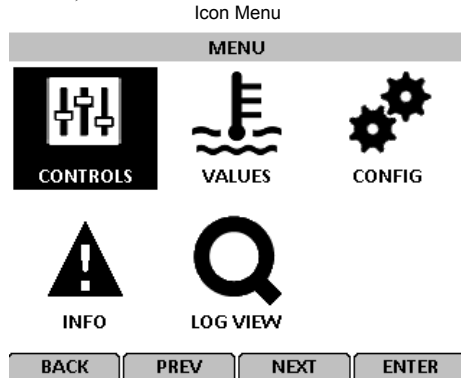

LOCK PADLOCK

If PADLOCK is active, contact technician, the technician must enter correct key (number) to unlock display. PADLOCK OPTION must be selected ON under the CONFIGURATION/ UNIT SETTING for it to be active or visible.

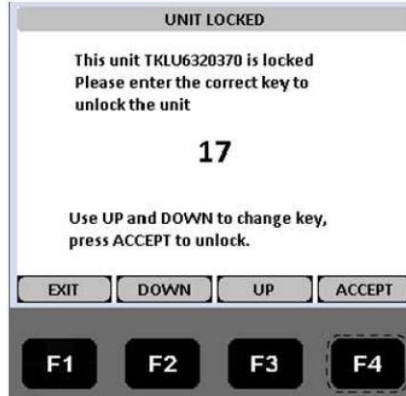

Lock Padlock



INITIATING A MANUAL DEFROST

Turn the **UNIT ON**. Allow Unit to start and stabilise. Complete the following steps:

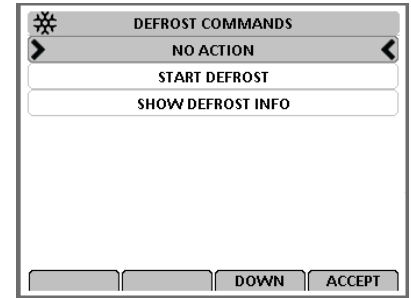

1. Press the **DEFROST** Special Function key.
 - If the unit operating conditions allow a manual defrost (e.g. evaporator coil temperature is less than 18 C [56 F]), the unit enters Defrost.
 - Select Start Defrost.
2. The defrost cycle automatically terminates and returns the unit to normal operation.



PTI

Turn the **UNIT ON**. Allow Unit to start and stabilise. Complete the following steps:

1. Press the **PTI** Special Function key.
2. Press the **F2/F3** keys to scroll down to select from the different PTI test.
3. Press the **F4** key to ACCEPT and start the PTI or test.



VIEWING ALARMS/ WARNINGS

To view the alarms that are present, turn the **UNIT ON**. Allow Unit to start and stabilise.

Complete the following steps:

1. Press the **F1/ALARM KEY**. The Alarm List appears.
2. Press the **F2/F3** keys to scroll between Alarms that are present.
3. Press the **F4** key to acknowledge the Alarm. Press **F1** again to exit.

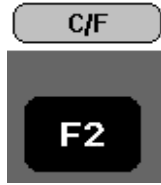

DISPLAY ALTERNATE FAHRENHEIT (F) OR CELSIUS (C) TEMPERATURES

To view the alarms that are present, turn the **UNIT ON**. Allow Unit to start and stabilise.

Complete the following step:

The controller can display temperatures in Celsius or Fahrenheit. Press the **F2** function key display will change to C or F

To change the display to C or F permanently, press and hold the **F2 C/F** key, then confirm "ARE YOU SURE YES or NO. Some customers do not allow the display to be change permanently.



CHANGING SETPOINT

To change the controller setpoint, turn the **UNIT ON**. Allow Unit to start and stabilise.

Complete the following steps:

1. Press the **F3** key at the main screen. The Setpoint Change menu appears.
2. Press the **F2/F3** keys to scroll the Setpoint Up or down - depending on your required Temperature.
3. Press and hold the **F4** key until you are returned to the main Screen. The new setpoint is recorded in the controller and appears in the display.

CONTROLLER BACK-UP BATTERY

Every Controller has a Back-up Battery. This will allow the controller to be energized if the unit is not connected to shore power. The technician can change settings in the controller - Setpoint, etc.

Press the ON/OFF key, the controller will energize and stay energized for 25 sec, by pressing any of the Menu keys the 25 sec timer will reset to 20 sec.

OPERATING THEORY

MAGNUM+ Operating Mode Function Chart

Chill Loads Setpoints at -9.9 C (14.4 F) and Above			Frozen Loads Setpoints at -10 C (14 F) and Below			Unit Function
Cool w/Mod	Heat	Defrost	Cool	Null	Defrost	
• ¹	•					Evaporator Fans High Speed ¹
• ¹			•	• ¹		Evaporator Fans Low Speed ¹
		•		• ¹	•	Evaporator Fans Off ¹
•	•			•		Proportional-integral Derivative (Supply Air) Control
			•	•		Return Air Sensor Control
		•			•	Evaporator Coil Sensor Control
•			•			Compressor On
•			•			Compressor Vapor Injection On (valve energized) ²
•			•			Condenser Fan On ³
•			• ⁴			Digital Control Valve Modulating (energized) ⁴
• ⁵	•	•			•	Electric Heaters Pulsing or On (energized) ⁵

¹Setpoint temperature and controlling mode setting determine the evaporator fan speed:

Normal Operation : Chill Loads — High or low speed fans; Frozen Loads — Low speed fans or no fans.

²Vapor injection valve:

Chill, Frozen or Power Limit Mode:

When the cool capacity is 100 percent.

Compressor High Temperature

Protection: When the compressor discharge temperature exceeds 138 C (280 F).

³Condenser fan pulses on and off on a 30 second duty cycle to maintain a minimum condenser temperature:

Chill Loads: Controller maintains a minimum 30 C (86 F) condenser temperature.

Frozen Loads: Controller maintains a minimum 20 C (68 F) condenser temperature.

⁴Digital Control valve modulates: Chill Loads — whenever the unit is in a Cooling mode; Power Limit — whenever the unit is in Power Limit mode.

Dehumidification: When the Dehumidify mode is set to On, the supply air temperature must be In-range to energize the electric heaters.

- When the humidity is 2 percent or more above humidity setpoint, the controller (energizes) the heaters.

⁵Controller energizes electric heaters for heat, defrost and dehumidification:

Heat mode (compressor off): If supply air temperature is too low, heaters pulse on and off on a 60 second duty cycle.

Defrost mode: Heaters are on until evaporator coil temperature increases to terminate defrost.

DIAGNOSIS: TROUBLESHOOTING, WARNINGS AND ALARM CODES

INTRODUCTION

This chapter includes the following:

- Introduction to Controller Diagnostics
- Troubleshooting charts
- Warnings chart
- Alarm Codes chart

The charts will help you identify and fix unit problems.

CONTROLLER DIAGNOSTICS

The MP4000 can be a very helpful diagnostic tool.

The following menu areas of the MP4000 controller menu will help you diagnose problems occurring with the Magnum unit.

Alarms/Warnings Menu: The Alarm/Warning list menu displays the code conditions. Alarm/Warning codes are recorded in the controller memory to simplify unit diagnosis procedures. Some alarm codes are only recorded during a Pretrip (PTI) test or function test. Fault codes are retained by the controller in a non-volatile memory. If the Red LED is on or flashing, enter the alarm list to view the alarm.

Brief PTI Test: The MP-4000 controller contains a special Brief PTI pretrip test that automatically checks unit refrigeration capacity, heating capacity, temperature control, and individual components including the controller display, solid state, contactor, fans, protection devices and sensors. The test includes measurement of component power consumption and compares test results to expected values. The test takes about 25-30 minutes to complete, depending on the container and ambient temperature. Refer to the Brief PTI Test in the Operating Instructions Section.

Full PTI Test: The MP-4000 controller contains a special Full PTI pretrip test that automatically checks unit refrigeration capacity, heating capacity, temperature control, and individual components including the controller display, solid state, contactor, fans, protection devices and sensors. The test includes measurement of component power consumption and compares test results to expected values. The test takes up to 2 to 2.5 hours to complete, depending on the container and ambient temperature. Refer to the Full PTI Test Menu in the Operating Instructions Section.

Functions Test: The MP-4000 controller contains a special function test that automatically tests individual components including the controller display, sensors, condenser fan, evaporator fan, compressors, etc. The test includes measurement of component power consumption and compares test results to expected values. Refer to the Functions Test Menu in the Operating Instructions Section.

Manual Functions Test: The Manual Function Test menu allows technicians to perform specific diagnostic tests on individual components or turn several components on at the same time to perform a system test. Refer to the Manual Functions Test Menu in the Operating Instructions Section.

Data: The Data menu displays general unit operating information including sensor temperatures, unit electrical data, etc. Refer to the Data Menu in the Operating Instructions Section.

EMERGENCY COLD LINE

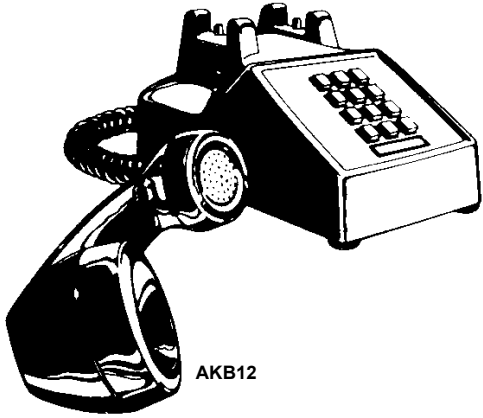

AKB12

If you can't get your rig rolling, and you have tried the Thermo King Container Service Directory (available from any Thermo King dealer) to reach a dealer without success, *then* call the Toll Free Emergency Marine Cold Line Number (800) 227-2506 or International number +1 (512) 712 1399. The answering service at the factory will assist you in reaching a dealer to get the help you need. The Cold Line is answered 24 hours a day by personnel who will do their best to get you quick service at an authorized Thermo King Dealer.



DECLARATION

Déclaration CE de conformité pour les machines / EC declaration of conformity for machinery / EG-Konformitätserklärung für maschinen / EO декларацията за съответствие за машини / ES prohlášení o shodě strojního zařízení / EF-Overensstemmelseserklæring / Δήλωση συμμόρφωσης EK για μηχανήματα / Declaración CE de conformidad sobre máquinas / EÜ vastavusavaldus masinate / EY-Vaatimustenmukaisuusvakuutus koneesta / EC izjava o skladnosti za strojeve / EK-Megfelelőségi nyilatkozatot a gép / Dichiarazione CE di conformità per macchine / EB atitikties deklaracijos mašinoms / EK atbilstības deklarācija attiecībā uz mašīnām / Dikjarazzjoni KE ta 'konformità għall-makkinarju / EG-Verklaring van overeenstemming voor machines / EC-Samsvarserklæring om maskiner / Deklaracja zgodności WE dla maszyn / Declaração CE de conformidade para as máquinas / Declarația CE de conformitate pentru mașini / ES-Декларация соответствия для машинного оборудования / Vyhlasenie o zhode ES pre strojové zariadenie / ES-izjava o skladnosti stroja / EG-Försäkran om överensstämmelse för maskinell utrustning / Makinalar için CE'ye uygunluk deklarasyonu / Декларация ЕС про відповідність машини

(Directive 2006/42/CE, 4.2, Ann. II, A)

Thermo King Container Temperature Control (Suzhou) Co., Ltd,
2333 PangJin Road, Wujiang City, 215200 Suzhou, JiangSu Province, PR China

Nom et adresse de la personne autorisée à constituer le dossier technique / name and address of the person authorised to compile the technical file / Name und Anschrift der Person, die bevollmächtigt ist, die technischen Unterlagen zusammenzustellen / имено и адреса на лицето, оторизирано да съставя техническото досие / jméno a adresu osoby pověřené sestavením technické dokumentace / navn og adresse på den person, der har bemyndigelse til at udarbejde det tekniske dossier / το όνομα και τη διεύθυνση του προσώπου του εξουσιοδοτημένου να καταρτίσει τον τεχνικό φάκελο / nombre y dirección de la persona facultada para elaborar el expediente técnico / selle ühenduses registrisse kantud isiku nimi ja aadress / sen henkilöön nimi ja osoite, joka on valtuutettu kokoamaan teknisen eritelmän / ime i adresu osobe koja je ovlaštena za prikupljanje tehničke dokumentacije / a műszaki dokumentáció összeállítására felhatalmazott személy / nome e indirizzo della persona autorizzata a costituire il fascicolo tecnico / asmens, įgalioto sudaryti atitinkamą techninę bylą / tās personas vārds un adrese, kura pilnvarota sastādīt tehnisko / l-isem u l-indirizz tal-persuna awtorizzata li tagħmel il-fajl tekniku / naam en adres van degene die gemachtigd is het technisch dossier samen te stellen / navn og adresse på personen som er autorisert til å kompilere den tekniske dokumentasjonen / nazwisko i adres osoby upoważnionej do przygotowania dokumentacji technicznej / Nome e endereço da pessoa autorizada a compilar o processo técnico / numele și adresa persoanei autorizate pentru întocmirea cărții tehnice / имя и адрес лица, уполномоченного составлять техническую документацию / meno a adresu osoby oprávnenej na zostavenie súboru technickej dokumentácie /

ime in naslov osebe, pooblaščene za sestavljanje tehnične dokumentacije / Namn på och adress till den person som är behörig att ställa samman den tekniska dokumentationen / kişinin adı ve adresi teknik dosyayı derlemek için yetkili / ім'я та адреса особи, уповноваженого складати технічну документацію

Thermo King Container – Denmark, Industrivej 2, 2550 Langeskov, Denmark

déclare ci-après que: herewith declares that: erklärt hiermit daß: следното изявление, че: prohlašuje se, že: erklærer herved at: και επιπλέον δηλώνει ότι: declaramos que el producto: järgmine kinnitus, et: vakuuttaa, että: sljedecu izjavu da: következő nyilatkozatot, hogy: dichiara che: taip, kad: šādu paziņojumu, ka: dikjarazzjoni li ġejja li: verklaart hiermede dat: herved erklæres at: następujące oświadczenie, że: pela presente declara que: următoarea declarație că: настоящим заявляет следующие: nasledujúce vyhlásenie, že: naslednjo izjavo, da: försäkrar härmed att: deklare ederki : таку заяву про те, що:

Machine / machinery /maschine / Машиностроение / maskinen / ταμμηχανήματα / marca / Machine / merkki / Stroj / Gép / modello / Mechanine / Machine / Magni / merk / merke / Machine / Máquina / Machine / Машинное оборудование / Stroj / Machine / märke / Model / Машина

MAGNUM +, MAGNUM, MAGNUM SL, CRR, CRR DF

est conforme aux dispositions des directives CEE suivantes : / is in conformity with the provisions of the following other EEC directives : / konform ist mit den einschlägigen Bestimmungen folgender weiterer EG-Richtlinien : / отговаря на следните ЕИО директиви : / je v souladu s ustanoveními následujících dalších směrnic ES : / er i overensstemmelse med følgende EU-direktiver : / εναρμόζονται με τα άρθρα των ακολούθων οδηγιών EEC / está, además, en conformidad con las exigencias de las siguientes directivas de la CE : / vastab järgmistele EMÜ direktiividele: / täyttää seuraavien ETY:n muiden direktiivien määräykset : / u skladu sa sljedećim smjernicama EEZ: / megfelel az alábbi EEC irányelveknek: / è conforme alle condizioni delle seguenti altre direttive CE / atitinka šiuos EEB direktyvas: / atbilst šādiem EEK direktīvām: / jikkonforma mad-direttivi tal-KEE li ġejjin: / voldoet aan de bepalingen van de volgende andere EEG-richtlijnen : / er i samsvar med bestemmelsene i følgende Øvrige EEC direktiver : / jest zgodny z następującymi dyrektywami EWG: / está conforme com as disposições das seguintes Directivas CEE : / indeplinește următoarele directivele CEE: / соответствует условиям следующих других директив ЕЭС: / v súlade s nasledujúcimi smernicami EHS: / v skladu z naslednjimi direktivami EGS: / är tillverkad i överensstämmelse med följande andra EEC direktiv : / ve aşağıdaki diğer Avrupa Topuluğu Tamimlerine uygundur : / y відповідності з наступними директивами ЕЕС :

2004/108/EC, 2006/95/EC, 2006/42/EC

et déclare par ailleurs que : / and furthermore declares that : / des weiteren erklären wir, daß : / u заявляе, че: / a dále se prohlašuje, že: /endvidere erklæres det: / και επιπλέον δηλώνει ότι / además declaramos que : / ja veel, et: / ja lisäksi vakuuttaa, että: /i dalje se navodi da: /továbbá megállapítja, hogy: / e inoltre dichiara che : / ir toliau teigia, kad: / un tālāk norāda, ka: /u wkoll li: / en verklaart voorts dat : /og videre erklæres at: / i dalje stwierdza, że: / mais declara que: /și alte state care: /u pruz tomom zayavlyat chto: /a dalej uvádza, že: /in nadalje navaja, da: / och försäkrar dessutom : / ve ayrıca teyit ederki : / i далі казуються, що:



Les parties/paragraphes suivants des normes harmonisées ont été appliquées. / The following parts/clauses of harmonized standards have been applied. / Folgende harmonisierten Normen oder Teile / Klauseln hieraus zur Anwendung gelangten. / Части следующие гармонизированы стандарты с приложениями. / byly použity následující části/ustanovení harmonizovaných technických norem / Eventuelt henvisning til de harmoniserede standarder / όροι των εναρμονισμένων με την οδηγία κανονισμών έχουν εφαρμοσθεί. / Las siguientes normas armonizadas, o partes de ellas, fueron aplicadas. / Parts / järgmiste ühtlustatud standardite kohaldamist. / Seuraavia yhdenmukaistettuja standardeja tai niiden osia/kohti) on sovellettu. / Dijelovi / slijedeći harmoniziranih standarda su primijenjene. / Alkatrészek követően harmonizált szabványokat alkalmazták. / Sono state applicate le seguenti parti/clausole di norme armonizzate. / Dalys / šie darnieji standartai nebuvo taikomi. / Parts / šādi saskaņoti standarti tika piemērots. / Partijiet li gešjin gew applikati standards armonizati. / De volgende onderdelen van geharmoniseerde normen zijn toegepast / Folgende deler/punkter i harmoniserte standarder har vært anvendt. / Części / następujące zharmonizowane normy zostały zastosowane. / Foram observadas as/os seguintes partes/parágrafos das normas harmonizadas : /Pieše urmātoare s-au aplicat standardele armonizate / Были применены следующие части/положения согласованных стандартов. / Parts nasledujúce harmonizované normy neboli použité. / Deli po usklajenih standardih, so bili uporabljeni. /Att följande harmoniserande standarder eller delar därav har tillämpats. / Aşağıdaki standartlar uygulanmıştır. / Части наступни узгоджени стандарти застосовувалися.

EN 349:1993+A1:2008 Safety of machinery - Minimum gaps to avoid crushing of parts of the human body

EN ISO 12100:2010 Safety of machinery - General principles for design - Risk assessment and risk reduction

EN ISO 13857:2008 Safety of machinery - Safety distances to prevent hazard zones being reached by upper and lower limbs

EN 60034-1:2010 Rotating electrical machines - Part 1: Rating and performance.

EN 60034-7:1993 Rotating electrical machines - Part 7: Classification of types of construction, mounting arrangements and terminal box position.

EN 60204-1:2006 Safety of machinery - Electrical equipment of machines - Part 1: General requirements.

EN 61000-6-1:2007 Electromagnetic compatibility (EMC) - Part 6-1: Generic standards - Immunity for residential, commercial and light-industrial environments

EN 61000-6-3:2007/A1:2011 Electromagnetic compatibility (EMC) - Part 6-3: Generic standards - Emission standard for residential, commercial and light-industrial environments

ISO 1496-2 1996 Series 1 freight container: specification and testing: thermal container

EN 378-1:2008 Refrigerating systems and heat pumps - Safety and environmental requirements - Part 1: Basic requirements, definitions, classification and selection criteria .

EN 12830:1999 Temperature recorders for the transport, storage and distribution of chilled, frozen, deep-frozen/quick-frozen food and ice cream. Tests, performance, suitability.

NF EN 13485 2001 Thermometers for measuring the air and product temperature for the transport, storage and distribution of chilled, frozen, deep-frozen/quick-frozen food and ice cream - Tests, performance, suitability.

NF EN 13486 2001 Temperature recorders and thermometers for the transport, storage and distribution of chilled, frozen, deep-frozen/quick-frozen food and ice cream - Periodic verification

La présente déclaration de conformité est établie sous la seule responsabilité du fabricant / This declaration of conformity is issued under the sole responsibility of the manufacturer / Die alleinige Verantwortung für die Ausstellung dieser Konformitätserklärung trägt der Hersteller / Настоящата декларация за съответствие е издадена на отговорността на производителя / Toto prohlášení o shodě vydal na vlastní odpovědnost výrobce / Denne overensstemmelseserklæring udstedes på fabrikantens ansvar / Η παρούσα δήλωση συμμόρφωσης εκδίδεται με αποκλειστική ευθύνη του κατασκευαστή / La presente declaración de conformidad se expide bajo la exclusiva responsabilidad del fabricante / Käesolev vastavusdeklaratsioon on välja antud tootja vastutusel / Tämä vaatimustenmukaisuusvakuutus on annettu valmistajan (tai asentajan) yksinomaisella vastuulla / Ova izjava o skladnosti je izdana na temelju isključiva odgovornost proizvođača / Ezt a megfelelőségi nyilatkozatot a gyártó kizárólagos felelőssége mellett adják ki / La presente dichiarazione di conformità è rilasciata sotto la responsabilità esclusiva del fabbricante / Ši atitikties deklaracija išduota tik gamintojo išimtinė atsakomybe / Št atbilstības deklarācija ir izdota vienīgi uz šāda ražotāja atbildību / Din id-dikjarazzjoni tal-konformità tinħareg taħt ir-responsabbiltà unika tal-manifattur / Deze conformiteitsverklaring wordt verstrekt onder volledige verantwoordelijkheid van de fabrikant / Denne erklæringen om samsvar er utstedt under ansvaret til produsenten / Niniejsza deklaracja zgodności wydana zostaje na wyłączną odpowiedzialność producenta / A presente declaração de conformidade é emitida sob a exclusiva responsabilidade do fabricante / Declarația de conformitate este emisă pe răspunderea exclusivă a producătorului / Эта декларация соответствия выдается под личную ответственность производителя / Toto vyhlásenie o zhode sa vydáva na výhradnú zodpovednosť výrobcu / Ta izjava o skladnosti se izda na lastno odgovornost proizvajalca / Denna försäkran om överensstämmelse utfärdas på tillverkarens eget ansvar / Uygunluk Bu beyan üreticinin sorumluluğunda altında verilir / Ця декларація відповідності видається під особисту відповідальність виробника

L'objet de la déclaration décrit ci-dessus est conforme à la législation communautaire d'harmonisation applicable / The object of the declaration described above is in conformity with the relevant Community harmonisation legislation / Der oben beschriebene Gegenstand der Erklärung erfüllt die einschlägigen Harmonisierungsrechtsvorschriften der Gemeinschaft / Предметът на декларацията, описан по-горе, отговаря на съответното законодателство на Общността за хармонизация / Výše popsaný předmět prohlášení je ve shodě s harmonizovanými právními předpisy Společenství / Genstanden for erklæringen, som beskrevet ovenfor, er i overensstemmelse med den relevante EF-harmoniseringslovgivning / Ο στόχος της δήλωσης που περιγράφεται παραπάνω είναι σύμφωνος προς τη σχετική κοινοτική νομοθεσία εναρμόνισης / El objeto de la declaración descrita anteriormente es conforme a la legislación comunitaria de armonización pertinente / Ülalkirjeldatud deklareeritav toode on kooskõlas asjaomaste ühenduse ühtlustatud õigusaktidega / Edellä kuvattu vakuutuksen kohde on asiaa koskevan yhdenmukaistamista koskevan yhteisön lainsäädännön vaatimusten mukainen / Predmet deklaracije gore opisane je u skladu s relevantnim zakonodavstvom Zajednice usklađivanje / A fent ismertetett nyilatkozat tárgya megfelel a vonatkozó közösségi harmonizációs jogszabálynak / L'oggetto della dichiarazione di cui sopra è conforme alla pertinente normativa comunitaria di armonizzazione / Pirmiau aprašytas deklaracijos objektas atitinka susijusius derinamuosius Bendrijos teisės aktus / Iepriekš aprakstītais deklarācijas priekšmets atbilst attiecīgajam Kopienas saskaņotajam tiesību aktam / L-ġħan tad-dikjarazzjoni deskritt hawn fuq huwa konformi mal-ġeġżlazzjoni ta' armonizzazzjoni rilevanti tal-Komunità / Het hierboven beschreven voorwerp is conform de desbetreffende communautaire harmonisatiewetgeving / Hensikten med erklæringen er beskrevet ovenfor er i samsvar med de relevante fællesskabsbestemmelser harmonisering regelverk / Wymieniony powyżej przedmiot niniejszej deklaracji jest zgodny z jednościami wymaganiami wspólnotowych przepisów harmonizacyjnych / O objecto da declaração acima mencionada está em conformidade com a legislação comunitária aplicável em material de harmonização / Obiectul declarației descris mai sus este în conformitate cu legislația comunitară relevantă de armonizare / Цель декларации описано выше в соответствии с соответствующим законодательством Сообщества согласования / Uvedený predmet vyhlášení je v súlade s príslušnými harmonizačnými právnymi predpismi Spoločenstva / Predmet navedene izjave je v skladu z ustrežno usklajevalno zakonodajo Skupnosti / Föremålet för försäkran ovan överensstämmer med den relevanta harmoniserade gemenskapslagstiftningen / beyan yukarıda tanımlanan nesne uygun olarak ilgili Topluluk uyum mevzuatı ile / Мета декларації описано вище у відповідності з відповідним законодавством Спільноти узгодження

DECLARATION

conformity assessment procedure followed / la procedure appliquee pour l'evaluation de la conformite/ procedura di valutazione della conformita seguida/ angewandtes Konformitatsbewertungsverfahren / procedimiento de evaluaci. n de la conformidad que se ha seguido / gevolgde overeenstemmingsbeoordelingsprocedure / Vilket forfarande for bedomning av overensstammelse som har foljts / den fulgte overensstemmelsesvurderingsprocedure / procedimento de avaliacao de conformidade/ выполнена процедура оценки соответствия / uzasadnienie zastosowanej procedury oceny zgodności oraz	machinery / machine / il modello / Maschine / marca / machine / maskinen / märke / máquina / машинное оборудование / maszyna	Max. Engine RPM	sound power level/ niveau de puissance acoustique/ livello di potenza sonora/ Schalleistungspegel / nivel de potencia acústica / geluidsvermogensniveau / ljudeffektivnivå / lydeffektniveau / nível de potência sonora / уровень звуковой мощности / poziom mocy akustycznej (Sound Power, dB)	
Module/ Module / Modulo / Modul / Módulo / Module / Modul / Modul / Modul / Модуль / Modul A	MAGNUM +	3550	Measured / mesuré / misurato / gemessener / medido / gemeten / Uppmätt / målt / garanteret / medido / Измерено / zmierzony	Guaranteed / garanti / garantita / garantierter / garantizado / gewaarborgd / Garanterad / garantido / Гарантировано / gwarantowany
			91	92

Place: Thermo King, Langeskov, Denmark
Allan Dyrmoose, Engineering & Technology Leader

Date:
02nd November 2014



Thermo King® is a brand of Ingersoll Rand. Ingersoll Rand (NYSE:IR) advances the quality of life by creating and sustaining safe, comfortable and efficient environments. Our people and our family of brands — including Thermo King®, Trane®, Ingersoll Rand®, Club Car® and Schlage® — work together to enhance the quality and comfort of air in homes and buildings; transport and protect food and perishables; secure homes and commercial properties; and increase industrial productivity and efficiency. We are a \$14 billion global business committed to a world of sustainable progress and enduring results.

europe.thermoking.com

thermoking.com

ingersollrand.com



Ingersoll Rand Alma Court Building - Lenneke Marelaan 6, B-1932 Sint-Stevens-Woluwe, Belgium.

© 2013 Ingersoll-Rand Company Limited TK 61110 Rev.0 (11-2013)